

# Data Sheet



Article number: 1080401091000  
Description: Servocontroller ACU401-09-FA  
1,1 kW 2,8A 3x400V IP20

## Measures

---

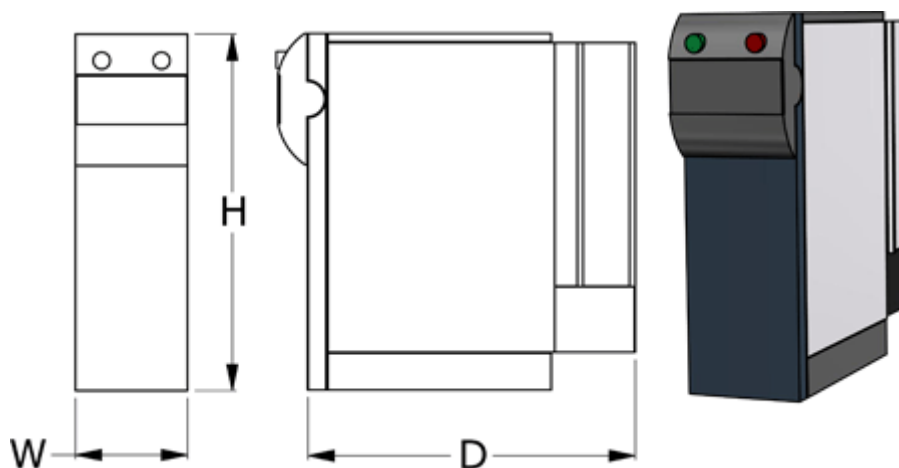

D = 175  
H = 190  
W = 60  
Weight = 1.2